

FASTENER NOTE

ALL EXTERIOR FASTENERS ARE TO BE EITHER STAINLESS OR PLATED CARBON STEEL.

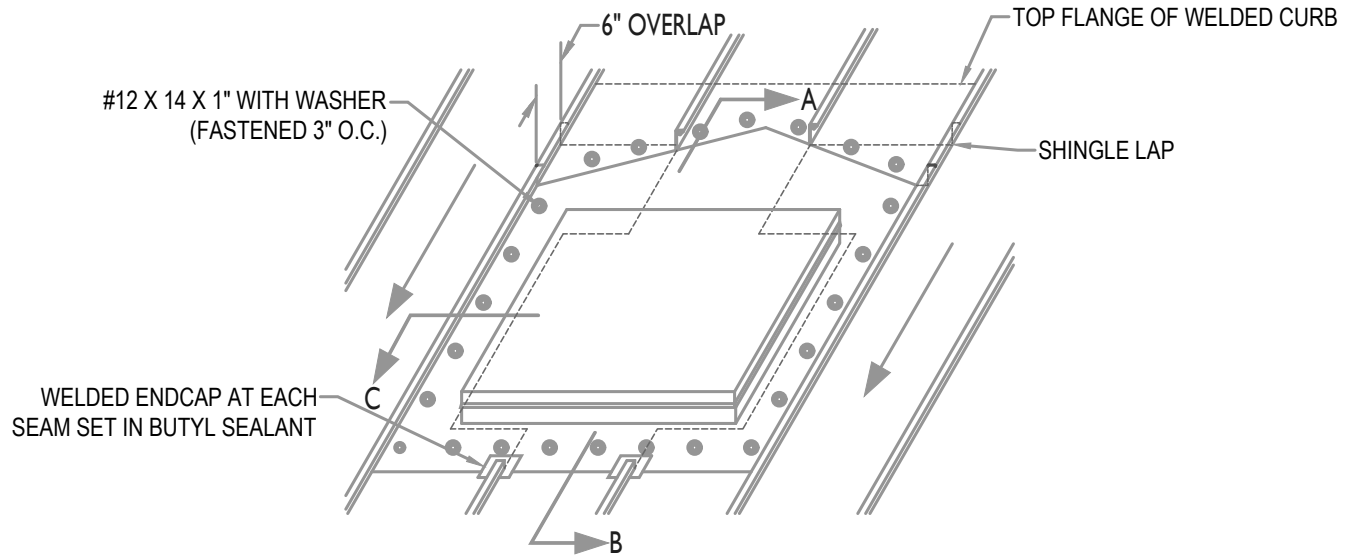

WELDED CURB DETAIL INSTRUCTIONS

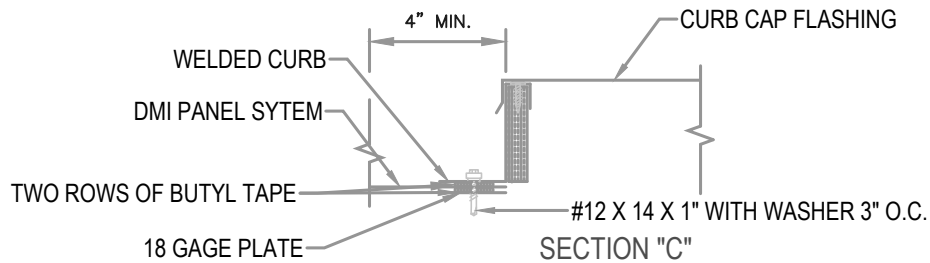
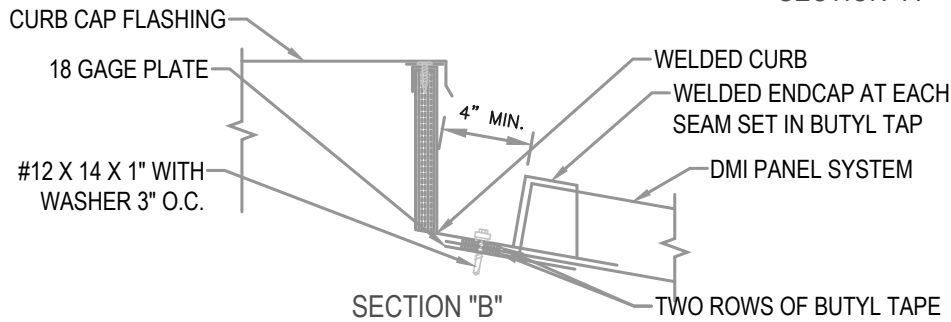
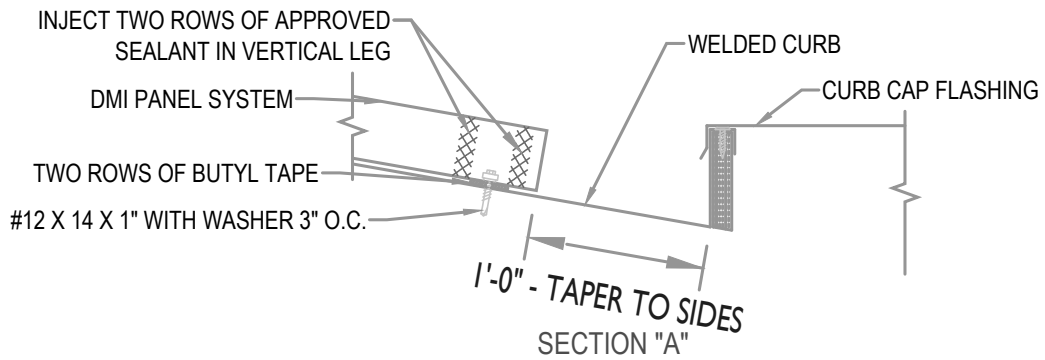

HYDROSTATIC CURB

• PROVEN • DEPENDABLE • SUSTAINABLE •
METAL ENVELOPE SYSTEMS SINCE 1988

WWW.DMIMETALS.COM

Detail:
SL25 10-00-WH

Issue/Rev Date:

01/17

Scale:

3"=1'-0"