

MAXIMUM PANEL ATTACHMENT FASTENER SPACING IS 24" O.C. ALL FASTENERS TO PENETRATE WOOD 3/4" MIN. AND METAL FRAMING 1/2" MIN.

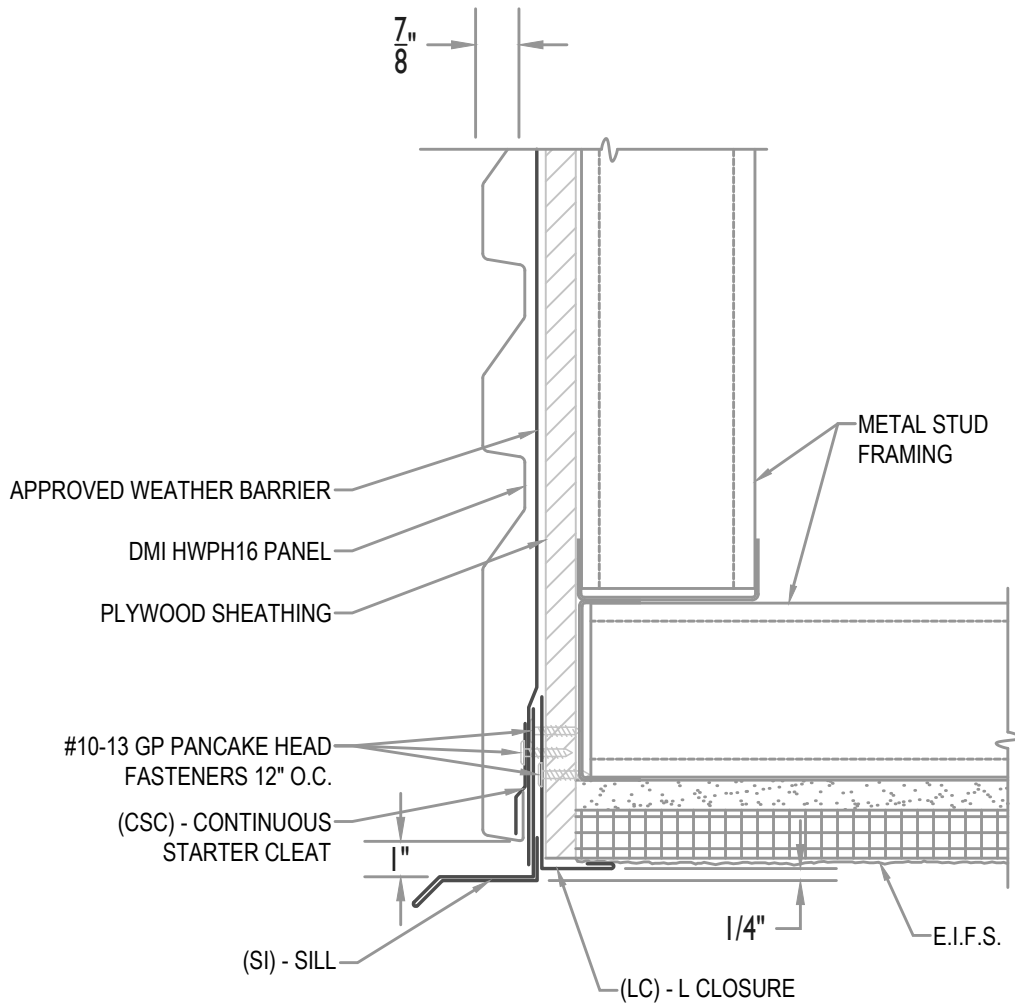

WALL PANEL W/ (EIFS SOFFIT)

• PROVEN • DEPENDABLE • SUSTAINABLE •

METAL ENVELOPE SYSTEMS SINCE 1988

WWW.DMIMETALS.COM

Detail: HWP16-H-02-00

Issue/Rev Date:

04/19

Scale:

3"=1'-0"